

4

3

2

1

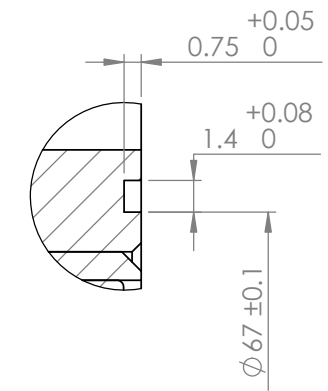

DETAIL A
O-RING GLAND
SCALE 3 : 1

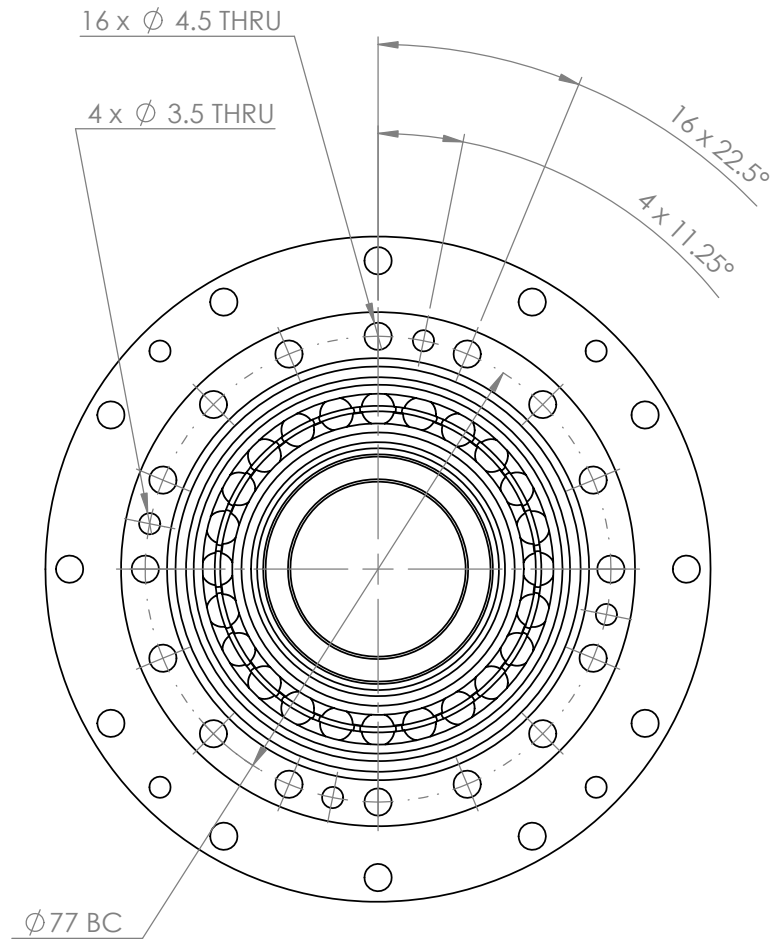
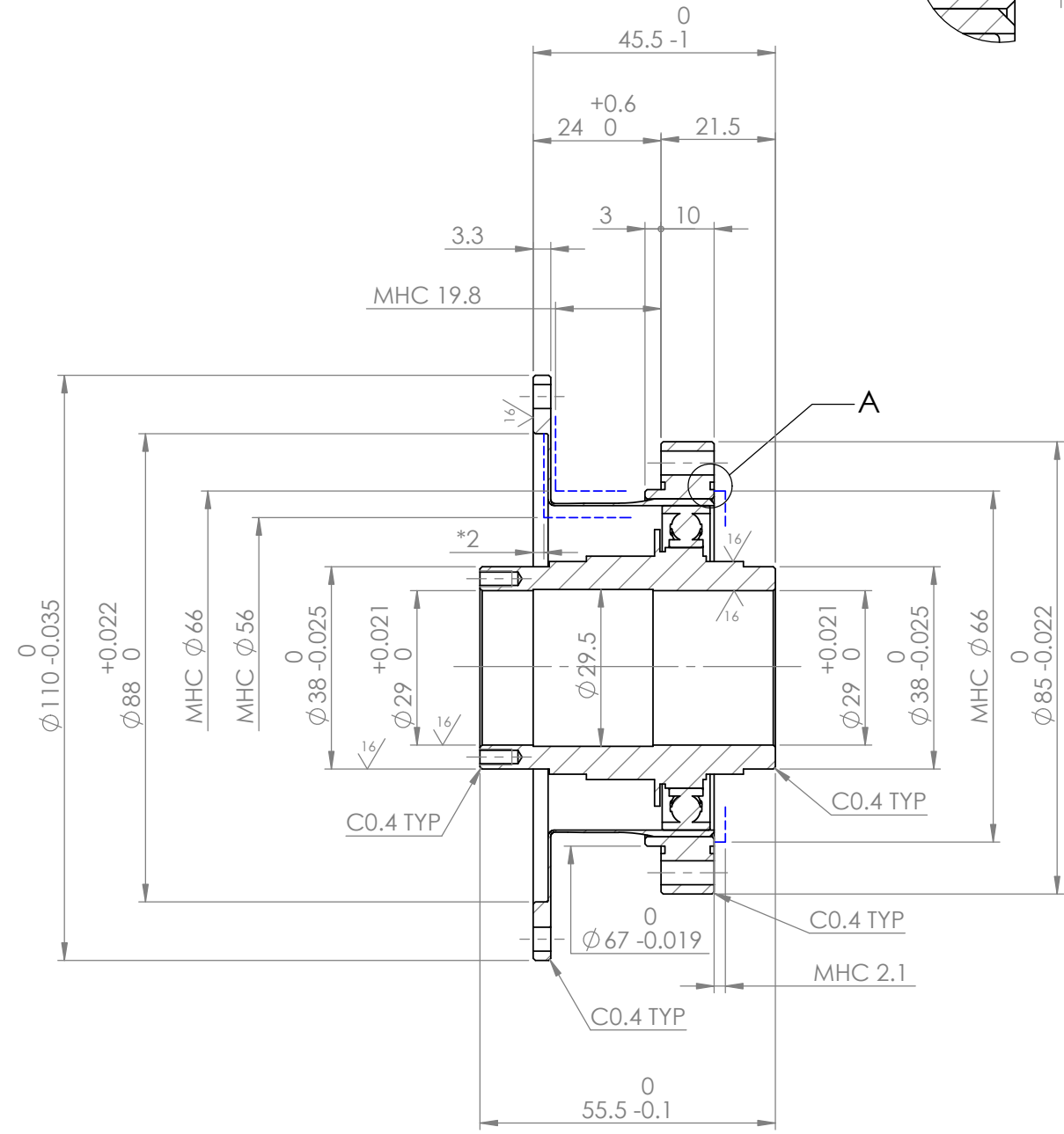
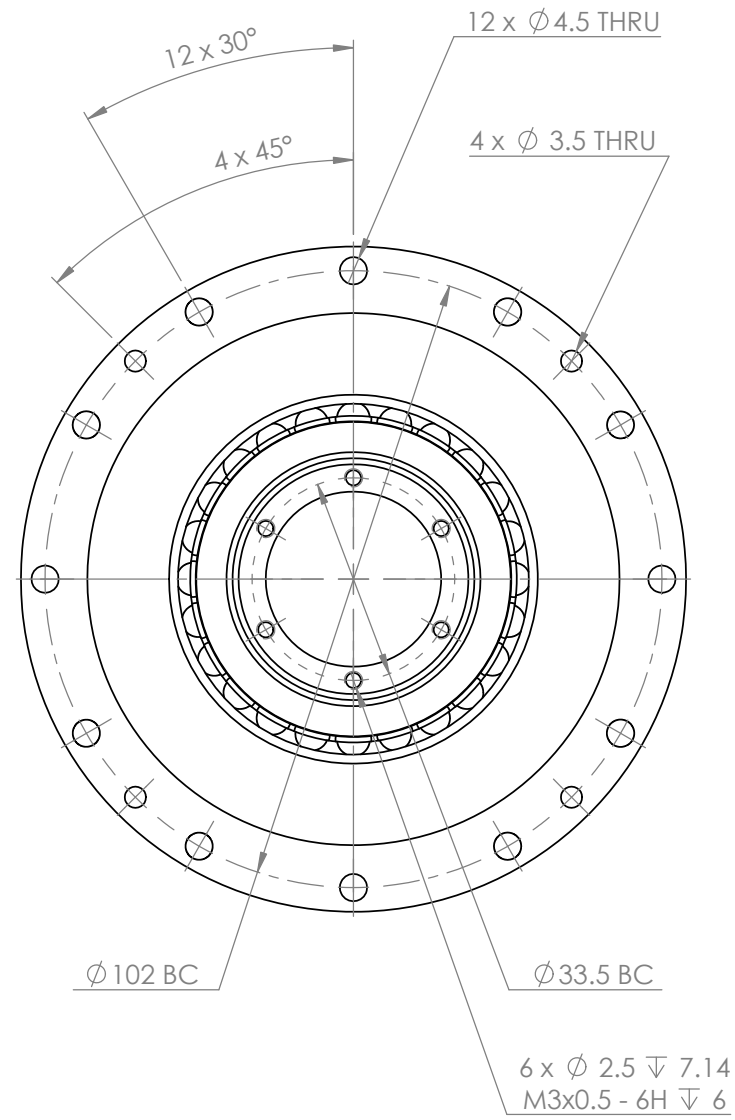

NOTE:
MHC = MINIMUM HOUSING CLEARANCE
* = MAXIMUM PILOT DEPTH

UNITS: MILLIMETERS			CONIC SYSTEMS		
DRAWN BY	JM	7/6/2018			
THIRD ANGLE PROJECTION			SHF SIZE 25 HARMONIC COMPONENT SET		
<small>PROPRIETARY AND CONFIDENTIAL THE INFORMATION CONTAINED IN THIS DRAWING IS THE SOLE PROPERTY OF CONIC SYSTEMS, INC. ANY REPRODUCTION IN PART OR AS A WHOLE WITHOUT THE WRITTEN PERMISSION OF CONIC SYSTEMS, INC. IS PROHIBITED.</small>			SIZE	DWG. NO.	REV
			B	SHF-025-XXX-M1	
			SCALE: 0.8:1	WEIGHT: GR	SHEET 1 OF 1

4

3

2

1

B

B

A

A